

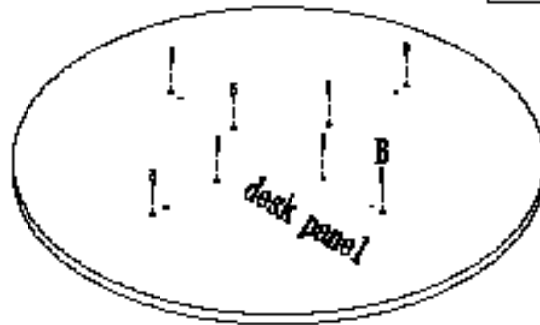

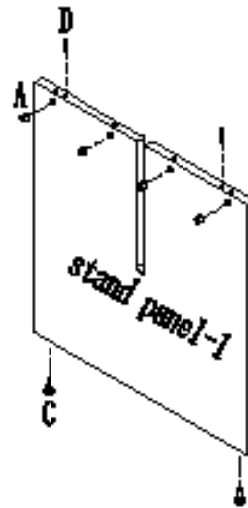

1





B*8

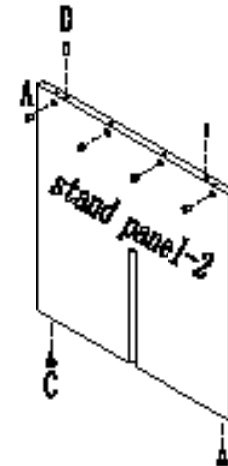

  
A*4 C*2 D*2



  
A*4 C*2 D*2

2

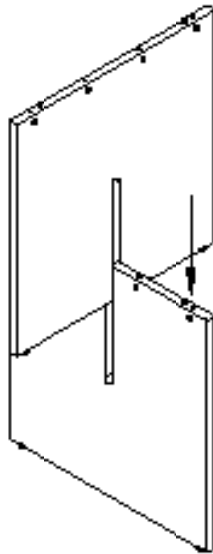

3

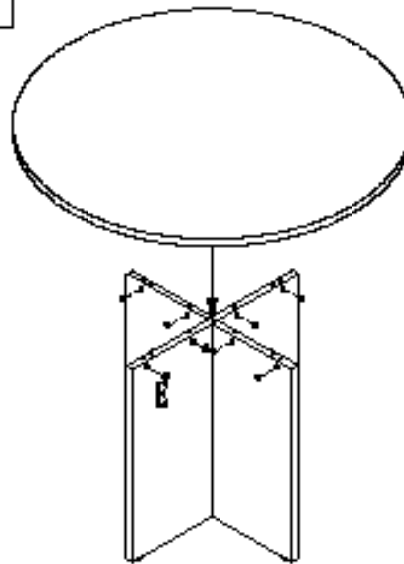

E*8

appearance



Hardware

NO.	symbol pic	name	QTY
A		Cam	8
B		Connector	8
C		Washer	4
D		Screw	4
E		Cam Lid (keep)	8